

**Steel duct**

Galvanized



Ext. dia. mm	Length m	Material thickness mm	Weight kg	Item no.
050	3 m	1.25	4.5	590105003
063	3 m	1.25	5.8	590106303
076	3 m	1.50	8.3	590105003
102	3 m	1.50	11.1	590110203
108	3 m	1.50	11.8	590110803
127	3 m	1.50	13.9	590112703
152	3 m	1.50	16.8	590115203
203	3 m	1.50	23.0	590120303
050	6 m	1.25	9.0	590105006
063	6 m	1.25	11.5	590106306
076	6 m	1.50	16.6	590107606
102	6 m	1.50	22.2	590110106
108	6 m	1.50	23.6	590110806
127	6 m	1.50	27.8	590112706
152	6 m	1.50	33.6	590115206
203	6 m	1.50	46.0	590120306



**Bend**  
Zinc-plated



**Technical information**

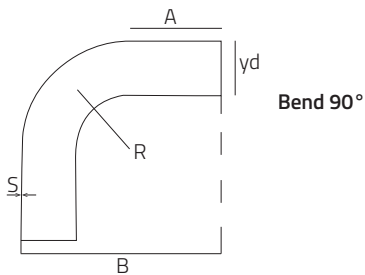
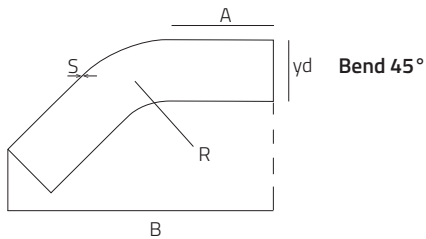

Ext. dia. mm	Bend	Material thickness mm	R x D mm	Item no.
050	45°	1.50	2.5	590205045
063	45°	1.50	2.0	590206345
076	45°	1.50	2.2	590207645
102	45°	2.00	1.5	590210245
108	45°	2.00	1.6	590210845
127	45°	2.00	1.3	590212745
152	45°	2.00	1.5	590215245
203	45°	2.00	1.5	590220345

Ext. dia. mm	Bend	Material thickness mm	R x D mm	Item no.
050	90°	1.50	2.5	590205090
063	90°	1.50	2.0	590206390
076	90°	1.50	2.2	590207690
102	90°	2.00	1.5	590210290
108	90°	2.00	1.6	590210890
127	90°	2.00	1.3	590212790
152	90°	2.00	1.5	590215290
203	90°	2.00	1.5	590220390

45° 45°	Yd mm	R mm	S mm	A mm	B mm	Weight kg
050-45	50	125	1.5	125	320	0.7
063-45	63	125	1.5	115	307	0.7
076-45	76	170	1.5	110	335	0.9
102-45	102	150	2.0	240	560	3.0
108-45	108	170	2.0	235	550	3.2
127-45	127	170	2.0	260	610	4.0
152-45	152	225	2.0	330	775	6.1
203-45	203	305	2.0	100	458	4.8

90° 90°	Yd mm	R mm	S mm	A mm	B mm	Weight kg
050-90	50	125	1.5	125	275	0.8
063-90	63	125	1.5	150	282	1.0
076-90	76	170	1.5	100	295	1.2
102-90	102	150	2.0	220	410	3.3
108-90	108	170	2.0	210	440	3.7
127-90	127	170	2.0	225	450	4.3
152-90	152	225	2.0	300	605	6.3
203-90	203	305	2.0	100	506	5.4

**Branch piece 45°**

Zinc-plated



**Technical information**

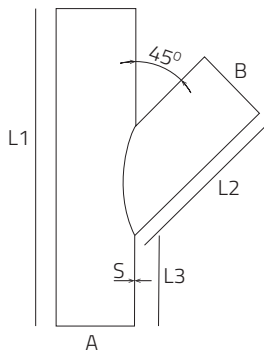

Diameter	A,C mm	B mm	L1 mm	L2 mm	L3 mm	S mm	Weight kg	Item no.
050-050	050	050	300	155	110	1.5	0.8	590305005
063-050	063	050	300	155	110	1.5	0.9	590306305
063-063	063	063	300	155	105	1.5	0.9	590306306
076-050	076	050	300	155	110	1.5	1.1	590307605
076-063	076	063	300	155	110	1.5	1.1	590307606
076-076	076	076	300	155	110	1.5	1.15	590307607
102-050	102	050	400	220	161	2.0	2.35	590310205
102-063	102	063	400	220	116	2.0	2.40	590310206
102-076	102	076	400	220	116	2.0	2.40	590310207
102-102	102	102	400	220	114	2.0	2.70	590310210
108-050	108	050	400	220	160	2.0	2.50	590310805
108-063	108	063	400	220	160	2.0	2.50	590310806
108-076	108	076	400	220	115	2.0	2.50	590310807
108-102	108	102	400	226	112	2.0	2.90	590310810
108-108	108	108	400	230	115	2.0	2.90	590310811
127-050	127	50	400	212	126	2.0	2.70	590312705
127-063	127	063	400	220	128	2.0	2.80	590312706
127-076	127	076	400	220	128	2.0	2.90	590312707
127-102	127	102	400	230	127	2.0	3.30	590312710
127-108	127	108	400	230	122	2.0	3.25	590312718
127-127	127	127	400	235	124	2.0	3.40	590312727
152-050	152	50	500	265	195	2.0	4.0	590315205
152-063	152	063	500	265	196	2.0	4.10	590315206
152-076	152	076	500	270	187	2.0	4.20	590315207
152-102	152	102	500	270	192	2.0	4.60	590315210
152-108	152	108	500	270	187	2.0	4.80	590315211
152-127	152	127	500	285	174	2.0	6.20	590315212
152-152	152	152	500	295	156	2.0	4.95	590315215
203-050	203	50	600	363	200	2.0	6.6	590320305
203-063	203	63	600	363	196	2.0	6.8	590320306
203-076	203	076	600	359	200	2.0	6.80	590320307
203-102	203	102	600	370	200	2.0	7.40	590320310
203-108	203	108	600	365	200	2.0	7.50	590320311
203-127	203	127	600	365	200	2.0	7.65	590320312
203-152	203	152	600	365	200	2.0	7.70	590320315
203-203	203	203	600	365	200	2.0	8.20	590320320

**Trouser Piece 45°**

Zinc-plated



Diameter mm	A mm	B,C mm	L1 mm	L2 mm	S mm	Weight kg	Item no.
050-050	050	050	150	100	2.0	0.7	590405050
063-063	063	063	150	100	2.0	0.9	590406306
076-076	076	076	150	100	2.0	1.35	590407607
102-102	102	102	150	100	2.0	2.10	590410210
108-108	108	108	200	150	2.0	3.0	590410810
127-127	127	127	200	150	2.0	3.65	590412712
152-152	152	152	200	150	2.0	4.4	590415215
203-203	203	203	200	150	2.0	6.1	590420315

**Technical information**

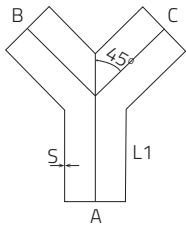

**Taper**

Zinc-plated



Diameter A mm	Diameter B mm	L mm	S mm	Weight kg	Item no.
050	0,38	125	1.5	0.30	590505003
063	050	125	1.5	0.25	590506305
076	050	130	1.5	0.50	590507605
076	063	125	1.5	0.40	590507606
102	063	150	2.0	0.70	590510206
102	076	140	2.0	0.69	590510207
108	063	150	2.0	0.70	590510806
108	076	135	2.0	0.72	590510807
108	102	120	2.0	0.72	590510810
127	076	170	2.0	1.05	590512707
127	102	145	2.0	1.05	590512710
127	108	135	2.0	0.87	590512718
152	102	150	2.0	0.80	590515210
152	108	160	2.0	1.35	590515211
152	127	150	2.0	1.10	590515212
203	127	150	2.0	1.35	590520312
203	152	180	2.0	1.30	590520315

**Technical information**

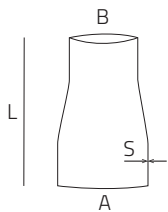

**End cover**

Zinc-plated



Diameter mm	Item no.
050	590520050
063	590520063
076	590520076
102	590520102

Diameter mm	Item no.
108	590520108
127	590520127
152	590520152
203	590520203

**Duct coupling**

galvanized with conductive EPDM rubber



Diameter mm	Item no.
050	590540050
063	590540063
076	590540076
102	590540102

Diameter mm	Item no.
108	590540108
127	590540127
152	590540152
203	590540203

**Strong Pipe Coupling, galvanized**

With FDA-approved NBR rubber, stainless steel strips and three electric galvanized bolts. Length: 150 mm



Diameter mm	Item no.
076	5905400761
102	5905401021
108	5905401081

Diameter mm	Item no.
127	5905401271
152	5905401521
203	5905402031

**Connector for rubber hose**

Hose clamp for rubber hose RUBE.



Diameter mm	Item no.
050	590905006
063	590905007
076	590905007
102	590905010

Diameter mm	Item no.
108	590905010
127	590905013
152	590905013

**JKF Hose clip**

Hose clip for PE and PUR hose



Diameter mm	Item no.
ø 38 - 50	8404009
ø 50 - 65	8404011
ø 58 - 75	8404012
ø 68 - 85	8404013

**Flap valve**

with conical entry for inserting into the duct



A: Indicates duct diameter  
B: ndicates diameter hose coupling

Ext. dia. A,B	Item no.
050-050	590805005
063-050	590806305
063-063	590806306

Ext. dia. A,B	Item no.
076-063	590807606
076-076	590807607

**Flap valve**

w/connection for duct coupling



Diameter mm	Item no.
063-050	590816305

Diameter mm	Item no.
063-063	590816306

**Flap valve with switch**

with conical entry for inserting into the duct and mechanical microswitch



A: Indicates duct diameter  
B: Indicates diameter hose coupling

Ext. dia. A,B	Item no.
050-050	590830500
063-050	590830630
063-063	590830632

Ext. dia. A,B	Item no.
076-063	590830760
076-076	590830762

**Flap valve**

w/taper for JKF pull rings



Diameter mm	Item no.
080-063	590808006

Diameter mm	Item no.
080-076	590808007

**Connector for hose coupling**



Diameter mm	Item no.
050-050	590918150
063-063	590918163

Diameter mm	Item no.
076-076	590918176

### Hose coupling

for mounting on hoses, combine with flap valve



A: Indicates the connection to the flap valve  
B: Indicates the hose diameter

$\varnothing$ udv. A,B Ext. dia. A,B	Item no.
050-038	590905003
050-050	590905005
063-050	590906305
063-063	590906306

$\varnothing$ udv. A,B Ext. dia. A,B	Item no.
076-050	590907605
076-063	590907606
076-076	590907607

### Micro switch

for Flap valve



Diameter mm	Item no.
SPLV-01	590830001

### Pneumatic sliding damper

with smooth edge



Diameter mm	Item no.
050	1461001
063	1461005
076	1461007
102	1461036

Diameter mm	Item no.
108	1461045
127	1461055
152	1461065
203	1461075

### Technical information

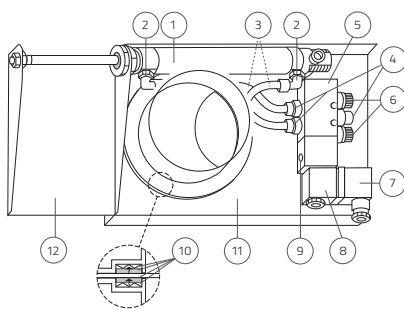

- 1 Pneumatic cylinder
- 2 Connection 1/8" - 6 mm hose
- 3 Hose 6 mm
- 4 Connection 1/8" - 6 mm hose
- 5 Solenoid valve
- 6 Silencer/adjustment
- 7 Cable terminal
- 8 Coil 230 V AC or 24 V AC/DC
- 9 Screw for manual operation of solenoid
- 10 Sealings
- 11 Damper housing
- 12 Damper blade

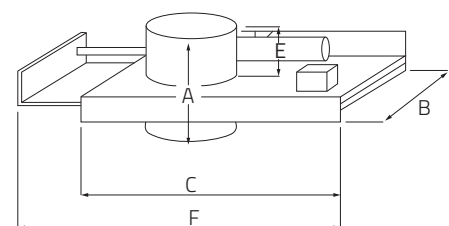

**Manual tight sliding damper**  
with smooth edge

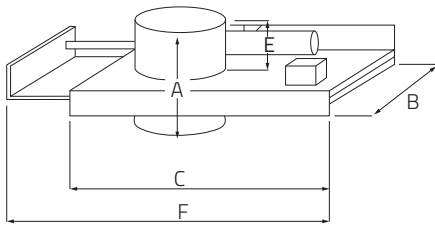

Diameter mm	A mm	B mm	C mm	E mm	F mm	Weight kg	Item no.
050	145	139.5	192.5	60	293	1.7	1460001
063	145	139.5	192.5	60	293	1.7	1460005
076	145	156.5	222.5	60	338	2.1	1460007
102	125	176.5	263	60	398	2.6	1460040
108	145	201.5	313.5	60	475	3.3	1460045
127	145	201.5	313.5	60	475	3.3	1460055
152	125	226.5	363	60	548	4.3	1460140
203	125	276.5	463	60	699	5.8	1460130

**Clamp**



Diameter mm	Item no.
050	590930050
063	590930063
076	590930076
102	590930102

Diameter mm	Item no.
108	590930108
127	590930127
152	590930152

**Duct support**



Diameter mm	Item no.
050	590920050
063	590920063
076	590920076
102	590920102

Diameter mm	Item no.
108	590920108
127	590920127
152	590920152

**Clamp with rubber inlay**



Diameter mm	Item no.
050	590920051
064	590920064
076-80	590920080
100-108	590920100

Diameter mm	Item no.
120-127	590920120
150-152	590920150
200	590920200



### Hose Reel

38 - 50



Diameter mm	Length	Weight kg	Item no.
038	8,5 m	12	On request

Diameter mm	Length	Weight kg	Item no.
050	7,3 m	14	On request

Equipped with anti-static vacuum hose. Spring Return with latch mechanism, that allows the hose to stay in the desired position. Micro switch that switches off the vacuum source when the hose is rolled up. Supplied with swivel bracket. Can be mounted on wall or ceiling. Connection diameter 50 mm.

### Rubber Hose

754



Int. dia. mm	Ext. dia. mm	Weight kg/m	Bending radius	Working pres. bar (20° C)	Vakuum %	Item no.
051	065	2.10	230	5	90	On request
063	078	3.10	300	5	90	On request
076	088	2.05	250	3	90	On request
102	116	3.67	400	3	90	On request
110	124	3.93	430	3	90	On request
127	141	5.11	500	3	90	On request
152	168	6.05	690	3	90	On request

### Roof support



Length	Item no.
2 meter	590922000

### Wall support

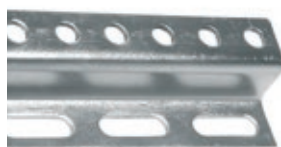

Length	Item no.
2 meter	590932000

### PE Hose

Antistatic PE hose.



Diameter mm	Length	Item no.
38	7,5 m	590919038
50	7,5 m	590919050
63	7,5 m	590919051
76	7,5 m	590919052

### PUR Hose

Polyurethane hose with hard PVC spiral and copper braid. Delivered in lengths.



Diameter mm	Length	Item no.
76	On request	590919076